



*Novità 2026*

 **VELAMP®**

**120<sup>o</sup>**

**ANNIVERSARIO**

**1906 - 2026**

*Buongiorno  
in attesa del nuovo catalogo generale Velamp  
2026 abbiamo pensato ad un breve, ma  
esaustivo, catalogo dedicato solamente alle  
novità già disponibili, o che comunque lo  
saranno a brevissimo*



LITHIUM BATTERY ( LiFePO4)



*...e ora le novità*

- 1 x COB LED  
1 x SMD LED  
1 x UV
- 500Lm
- 5 Hours
- 15m
- Diffuse Light
- Focus Light
- Li-ion  
3,7V 2000mAh  
(included)



**500  
LUMEN**

# IR475



- 5W COB PANEL
- 3 MAGNETS
- 398 nm UV
- HOOK
- EMD FLASHLIGHT
- RICARICABILE  
RECHARGEABLE
- ORIENTABLE



- 
- IP20
- DIMMABLE
- 6500K**
- CLASSE 3

Articolo	Descrizione	PACKING 	INNER pcs	MASTER pcs
<b>IR475</b>	FONZIE: lampada di lavoro 500 lumen con base di ricarica. LED + UV + torcia	Blister	6	24

- 3 x COB LED
- 800 Lumen
- 6 Hours
- 15 m
- Diffuse
- Li-ion  
3,7V 2000mAh  
(included)



# IR480



- 
- IP20
- DIMMABLE
- 6500K**
- CLASSE 3

Articolo	Descrizione	PACKING 	INNER pcs	MASTER pcs
<b>IR480</b>	PAUL: lampada di lavoro ricaricabile 500 lumen su mini treppiede	Color/Box	6	24

**1W**  
**100 LUMEN**

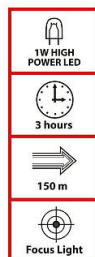

## IR551NG

Articolo	Descrizione	PACKING ☐ / ☑	INNER ☐ pcs	MASTER ☐ pcs
<b>IR551NG</b>	<b>MARTY</b> : faro ricaricabile 1W / 100lm. IP43 con cavo USB. Nero	Color Box	6	24

**350 LUMEN**  
**5W**

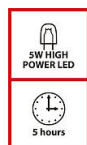

## IR554NG

Articolo	Descrizione	PACKING ☐ / ☑	INNER ☐ pcs	MASTER ☐ pcs
<b>IR554NG</b>	<b>ICARO 5W</b> : faro ricaricabile 5W / 350lm. IP43 con cavo USB. Antracite	Color Box	6	24

**10W**



## IR558NG

Articolo	Descrizione	PACKING ☐ / ☑	INNER ☐ pcs	MASTER ☐ pcs
<b>IR558NG</b>	<b>HORNET 10W</b> : faro ricaricabile 10W / 700lm. IP43 con cavo USB. Rosso	Color Box	6	24



-  30W SMD LED
-  3000 Lumen
-  120° Flood
-  12 Hours max
-  18650 Li-ion  
7.4V 6600 mAh
-  USB Powerbank
-  IP54

**3000 LUMEN**

**30W**

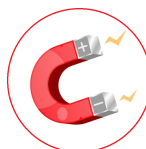

**IR868**



**COLOUR CHANGE**  
 3000K 4000K 6500K



Articolo	Descrizione	PACKING / /	INNER pcs	MASTER pcs
<b>IR868</b>	<b>CROW:</b> proiettore LED 30W / 3000lm ricaricabile. IP54. CCT: 3000K / 4000K / 6500K. Colore Nero	Color Box	4	4

**4500  
LUMEN**

LED 2835 SMD
<b>50W</b>
220-240V - 50/60Hz
DIFFUSE 110°
<b>IP65</b>
2m CABLE
HGRN F 2x1,0mm <sup>2</sup>



**IS766NG-2**



Articolo	Descrizione	PACKING ☐ / ☑	INNER ☐ pcs	MASTER ☐ pcs
<b>IS766NG-2</b>	<b>WAINGRO 50W:</b> Proiettore LED SMD 50W da lavoro con staffa a terra e cavo 2m	Color Box	1	8

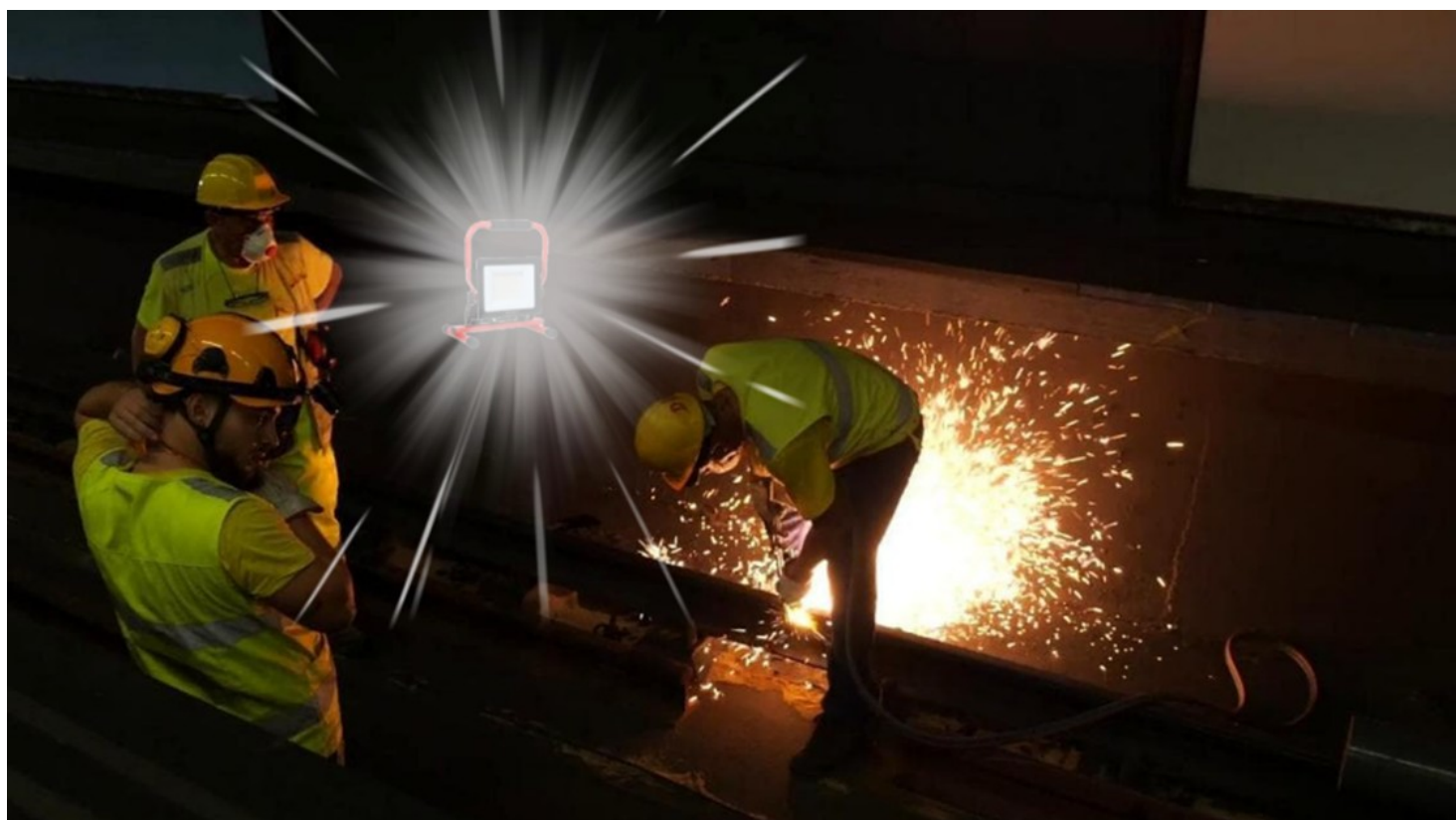

- LED 2835 SMD
- 20W**
- 220-240V ~ 50/60Hz
- DIFFUSE 110°
- IP65**
- 155 cm MAX
- 3m CABLE  
H05RN-F 3G1.0mm<sup>2</sup>



**1800 LUMEN**

# IS749NG

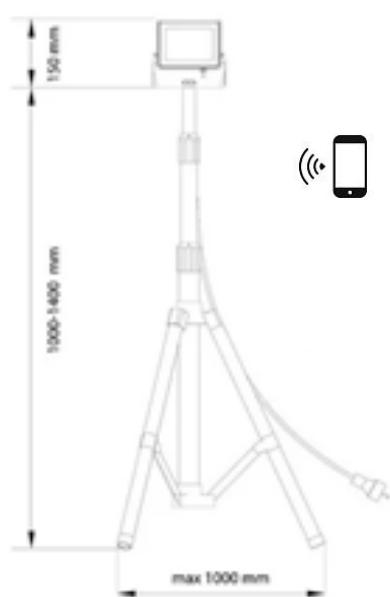

CE **IP65** **4000K** **TUV SUD** **CLASSE I**

Articolo	Descrizione	PACKING ☐ / ☐	INNER ☐ pcs	MASTER ☐ pcs
<b>IS749NG</b>	Proiettore LED SMD 20W, IP65, con treppiede e cavo 3mt	Color Box	6	6

- LED SMD
- 120° FLOOD
- IP65**
- 220-240V ~ 50Hz
- 3m CABLE  
H05RN-F 3G1.0mm<sup>2</sup>



**2X 20W**

**2X 1600 LUMEN**

# IS747NG-2

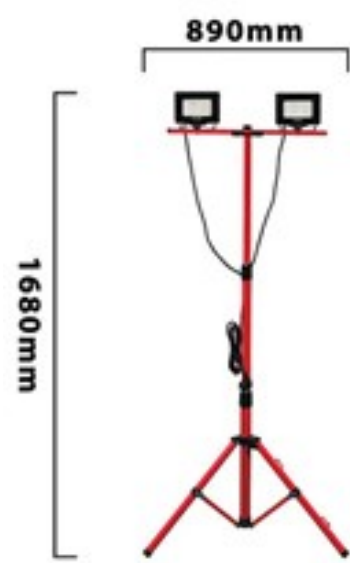

**4000K**

**F A ↑ G**

**IP65** **CLASSE I** **CONTAINING PRODUCT** **F**

Articolo	Descrizione	PACKING ☐ / ☐	INNER ☐ pcs	MASTER ☐ pcs
<b>IS747NG-2</b>	<b>TWIN HEAD:</b> Luce da lavoro LED 2 x 20W SMD + treppiede	Color Box	6	6

**COB LED**  
**280 LUMEN**





-  3W COB
-  8 Hours
-  Diffuse
-  3 x AA (NOT INCLUDED)



# IS464



CE  IP20  NOT DIMMABLE **6000K**

Articolo	Descrizione	PACKING  / 	INNER  pcs	MASTER  pcs
<b>IS464</b>	<b>PAGAY:</b> Luce da lavoro COB LED con calamita e gancio	Display	12	72





**3W LED**



# IC208

**PUSHUP:**  
mini lanterna 3AAA



Articolo	Descrizione	PACKING  / 	INNER  pcs	MASTER  pcs
<b>IC208</b>	<b>PUSHUP:</b> mini lanterna 3AAA	Display 12 pz.	12	48

Li-ion  
**800mAh**



# VENT-P10R



**RECHARGEABLE**



12 pcs  
**DISPLAY**

**IP20**

**CLASSE 3**

Articolo	Descrizione	PACKING ☐ / ☑	INNER ☐ pcs	MASTER ☐ pcs
<b>IS464</b>	<b>FRESH:</b> mini ventilatore a mano ricaricabile.2 colori assortiti	Display 12pz.	12	12





**APOLUX**

**SPH950**

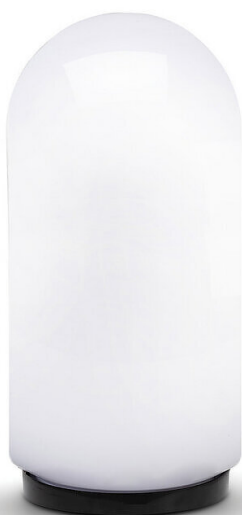

**Base included**



Articolo	Descrizione	PACKING ☐ / 📦	INNER ☐ pcs	MASTER ☐ pcs
<b>SPH950</b>	<b>APOLUX:</b> Cupola per esterno in PMMA, 15X28cm, E27, bianco	Polybag	4	4



## SPH951



Articolo	Descrizione	PACKING ☐ / 📦	INNER ☐ pcs	MASTER 📦 pcs
<b>SPH951</b>	<b>APOLUX:</b> Cupola per esterno in PMMA, 15X28cm, E27, Trasparente	Polybag	4	4



## SPH960



Base included



Articolo	Descrizione	PACKING ☐ / 📦	INNER ☐ pcs	MASTER 📦 pcs
<b>SPH960</b>	<b>APOLUX:</b> Ampola per esterno in PMMA, 21,5 x 29,5cm, base E27, bianco opaco.	Polybag	4	4



# SPH960



Articolo	Descrizione	PACKING ☐ / ☑	INNER ☐ pcs	MASTER ☐ pcs
<b>SPH960</b>	<b>APOLUX:</b> Ampola per esterno in PMMA, 21,5 x 29,5cm, base E27, Trasparente	Polybag	4	4

**1 Choose your globe diameter:**

**2 Choose the colour of your globe:**

transparent 
 white 
 frosted white 
 smoked

**3 Choose installation:**

**on pole:**

+   
 choose the pole length: 0.5m / 1m / 1.5m / 2m / 2.4 m      **SPH162 base**

**If you want to install 2 globes**

+ + OR   
 you must use the **SPH182 connector**      **SPH160** for globes 200 / 250 / 300mm      **SPH162** for globes 400mm

**If you want to install 3 globes**

+ + OR   
 you must use the **SPH183 connector**      **SPH160** for globes 200 / 250 / 300mm      **SPH162** for globes 400mm

**on wall:**

OR   
**SPH160** for globes 200 / 250 / 300mm      **SPH162** for globes 400mm

**on stand:**

OR   
 Short base: **SPH140**      Long base **SPH142**



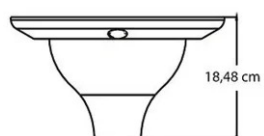
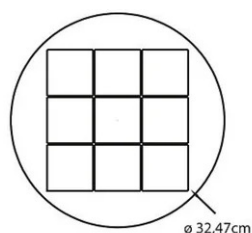

- 2300 Lumens
- 13W
- Weatherproof
- Lighting
- Smart
- Dimmable
- DALI
- IP65



**Telecomando incluso**  
*Remote control included*

-  SMD LED
- 2200**  
Lumen
- 15W**
-  Diffuse light
-  LiFePO4  
12.000 mAh  
(Replaceable)
-  Mono-crystalline  
silicone 8.5W
- 
-  IP65







# SPH210S



 YouTube



Articolo	Descrizione	PACKING  / 	INNER  pcs	MASTER  pcs
<b>SPH210S</b>	Sfera solare LED per esterni in PMMA, 200mm, 3 CCT, 2000 lumen, IP65. Bianco	Brown Box	2	2

-  SMD LED
- 2200**  
Lumen
- 15W**
-  Diffuse light
-  LiFePO4  
12.000 mAh  
(Replaceable)
-  Mono-crystalline  
silicone 8.5W
- 
-  IP65







# SPH215S



 YouTube



Articolo	Descrizione	PACKING  / 	INNER  pcs	MASTER  pcs
<b>SPH215S</b>	Sfera solare LED per esterni in PMMA, 200mm, 3 CCT, 2000 lumen, IP65. Trasparente	Brown Box	2	2

# Abbinabili agli accessori APOLUX

Cod. prod. Item code	Foto Photo	Descrizione Description	Materiale Materials	Dim. (L1 x L2 x L3) Dimensions	QRcode QRcode	Tipologia imballaggio Packaging type	Inner 	Master 
SPH105		Palo 0,5m 0,5m pole Mât 0,5m Barra 0,5 m Stange 0,5m	PLASTIC - ABS	500 x 70 x 70 mm		Bulk	12	12
SPH110		Palo 1m 1m pole Mât 1m Barra 1m Stange 1m	PLASTIC - ABS	1000 x 70 x 70 mm		Bulk	12	12
SPH115		Palo 1,5m 1,5m pole Mât 1,5m Barra 1,5 m Stange 1,5m	PLASTIC - ABS	1500 x 70 x 70 mm		Bulk	4	4
SPH120		Palo 2m 2m pole Mât 2m Barra 2m Stange 2m	PLASTIC - ABS	2000 x 70 x 70 mm		Bulk	4	4
SPH124		Palo 2,4m 2,4m pole Mât 2,4m Barra 2,4m Stange 2,4m	PLASTIC - ABS	2400 x 120 x 120 mm		Bulk	4	4
SPH140		Base corta Short stand Petite base Base corta Kurzer Stand	PLASTIC - ABS	118 x 118 x 120 mm		Bulk	10	50
SPH142		Base lunga Long stand Grande base Base lunga Langer Stand	PLASTIC - ABS	140 x 140 x 180 mm		Bulk	10	50
SPH150		Braccio corto Short arm Bras court Brazo corto Kurzer Arm <b>Only for globes with ø 200, 250, 300 mm</b>	PLASTIC - ABS	230 x 100 x 100 mm		Bulk	10	50
SPH152		Braccio lungo Long arm Bras long Brazo largo Kurzer Arm <b>Only for globes with ø 350, 400 mm</b>	PLASTIC - ABS	320 x 100 x 100 mm		Bulk	10	50
SPH162		Base da pavimento Floor base Base de fixation au sol Base de suelo Bodenplatte	PLASTIC - ABS	170 x 70 x 170 mm		Bulk	6	36
SPH182		Testa palo per fissaggio 2 sfere 2 heads connector	PLASTIC - ABS	130 x 100 x 87 mm		Bulk	1	50
SPH183		Testa palo per fissaggio 3 sfere 3 heads connector	PLASTIC - ABS	140 x 100 x 130 mm		Bulk	1	50





# SL257



Articolo	Descrizione	PACKING ☐ / ☐	INNER ☐ pcs	MASTER ☐ pcs
<b>SL257</b>	Applique a ricarica solare 800 lumen, Luce solare LED Esterno con rilevatore di movimento. 3 tonalità di luce a scelta. Senza cavi. IP65: ideale per esterno, balcone, giardino terrazzo	Color Box	6	24









# SL374NG

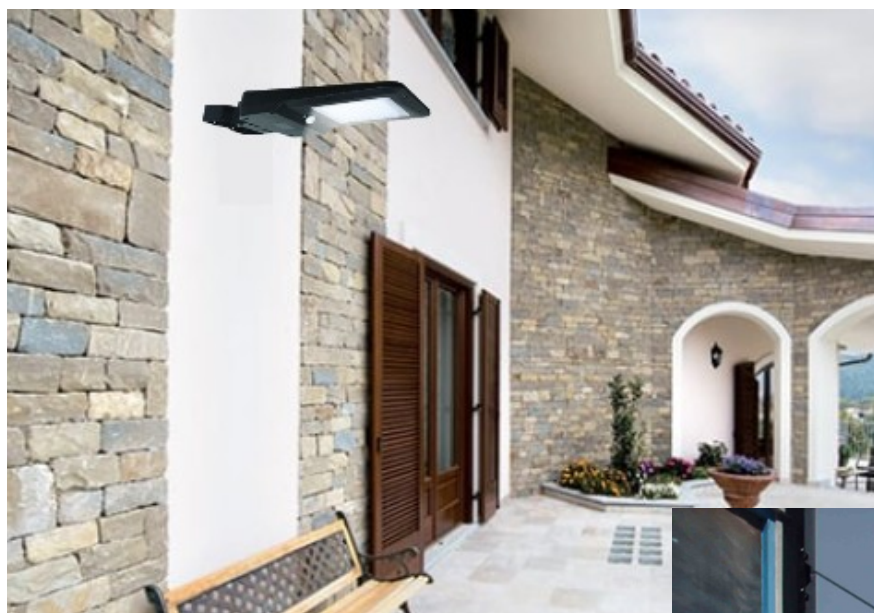





Articolo	Descrizione	PACKING ☐ / ☐	INNER ☐ pcs	MASTER ☐ pcs
<b>SL374NG</b>	Lampione solare 20W (3000lm) con sensore di movimento, Faretto a ricarica solare, luce di sicurezza con 3 colori di luce a scelta. Per esterni, parcheggi, giardini, cortili aziende...Impermeabile IP65	Color Box	1	8



# SL369

-  2 x 3W  
High power LED
-  2 x 100  
LUMEN
-  8 ore / hours
-  Li-Ion  
3,7V 2000mAh  
(type 18650 replaceable)
-  FOCUS LIGHT
-  Poly-silicon  
solar panel  
5.5V 2W
- 



Articolo	Descrizione	PACKING  / 	INNER  pcs	MASTER  pcs
SL369	<b>BLACKBIRD:</b> kit di 2 faretti LED in plastica a carica solare	Color Box	4	16



 3W LED SMD
 200 LUMEN
 >10 HOURS
 2 x 18650 Li-ion 3.7V 1800mAh
 USB TYPE C
 IP44



RGB+W

ø8cm

ø11,5cm





ø10,9cm







## TL1909-W



35,5cm



Articolo	Descrizione	PACKING  / 	INNER  pcs	MASTER  pcs
<b>TL1909-W</b>	<b>JOSEPHINE 2:</b> Lampada da tavolo LED touch ricaricabile Bianco + RGB. Interno / esterno. Colore Bianco	Color Box	6	6





 3W LED SMD
 200 LUMEN
 >10 HOURS
 2 x 18650 Li-ion 3.7V 1800mAh
 USB TYPE C
 IP44



RGB+W

## TL1909-C



Articolo	Descrizione	PACKING  / 	INNER  pcs	MASTER  pcs
<b>TL1909-C</b>	<b>JOSEPHINE 2:</b> Lampada da tavolo LED touch ricaricabile Bianco + RGB. Interno / esterno. Colore Corten	Color Box	6	6

**LED**

**450 LUMEN**  
∠360°

120°  
DIFFUSE

**T5**  
SHAPE

**IP20**

**E**



**TRICOLOR TECHNOLOGY**  
3000K 4000K 6500K

# RS4-4CCT



CE IP20 DIMMABLE COLOUR CHANGE 3000K 4000K 6500K intertek CLASSE 2 CONTAINING PRODUCT E



Articolo	Descrizione	PACKING	INNER	MASTER
<b>RS4-4CCT</b>	<b>DURANDAL:</b> Reglette 26 LED T5 4W 31cm con interruttore, 3 CCT: 3000K / 4000K / 6500K	Color Box	10 pcs	30 pcs

**LED**

**900 LUMEN**  
∠360°

120°  
DIFFUSE

**T5**  
SHAPE

**IP20**

**E**



**TRICOLOR TECHNOLOGY**  
3000K 4000K 6500K

# RS8-8CCT



CE IP20 DIMMABLE COLOUR CHANGE 3000K 4000K 6500K intertek CLASSE 2 CONTAINING PRODUCT E

① Collegabili tra loro fino a 120W ② Connectable to each other up to 120W  
③ Connectables entre eux jusqu'à 120 W ④ Conectables entre sí hasta 120W  
⑤ Untereinander verbindbar bis 120W

Articolo	Descrizione	PACKING	INNER	MASTER
<b>RS8-8CCT</b>	<b>DURANDAL:</b> Reglette LED T5 8W 57,3cm con interruttore, 3 CCT: 3000K / 4000K / 6500K	Color Box	6 pcs	6 pcs

**LED**

**1200 LUMEN**  
∠360°

120°  
DIFFUSE

**T5**  
SHAPE

**IP20**

**E**



**TRICOLOR TECHNOLOGY**  
3000K 4000K 6500K

CE

**IP20**

**DIMMABLE**

**COLOUR CHANGE**  
3000K 4000K 6500K

intertek

**CLASSE 2**

CONTAINING PRODUCT  
**E**

Ⓛ Collegabili tra loro fino a 120W Ⓞ Connectable to each other up to 120W  
Ⓜ Connectables entre eux jusqu'à 120 W Ⓨ Conectables entre si hasta 120W  
Ⓟ Untereinander verbindbar bis 120W

# RS10-10CCT



Articolo	Descrizione	PACKING ☐ / ☑	INNER ☐ pcs	MASTER ☐ pcs
<b>RS10-10CCT</b>	<b>DURANDAL:</b> Reglette 26 LED T5 10W - 87,3cm con interruttore, 3 CCT: 3000K / 4000K / 6500K	Color Box	10	30

**LED**

**1600 LUMEN**  
∠360°

120°  
DIFFUSE

**T5**  
SHAPE

**IP20**

**E**



**TRICOLOR TECHNOLOGY**  
3000K 4000K 6500K

CE

**IP20**

**DIMMABLE**

**COLOUR CHANGE**  
3000K 4000K 6500K

intertek

**CLASSE 2**

CONTAINING PRODUCT  
**E**

# RS14-14CCT



Articolo	Descrizione	PACKING ☐ / ☑	INNER ☐ pcs	MASTER ☐ pcs
<b>RS14-14CCT</b>	<b>DURANDAL:</b> Reglette LED T5 14W - 117,3cm con interruttore, 3 CCT: 3000K / 4000K / 6500K	Color Box	6	6



## TL1204-B



Articolo	Descrizione	PACKING ☐ / ☐	INNER ☐ pcs	MASTER ☐ pcs
<b>TL1204-B</b>	<b>BAKER:</b> Lampada da tavolo bianca con attacco E27	Color Box	6	6



## TL1204-N



Articolo	Descrizione	PACKING ☐ / ☐	INNER ☐ pcs	MASTER ☐ pcs
<b>TL1204-N</b>	<b>BAKER:</b> Lampada da tavolo nera con attacco E27	Color Box	6	6

- LED
- 72 SMD LED
- DIFFUSE LIGHT
- 10W POWER CONSUMPTION

- x1,75 MAGNIFICATION
- 1050 LUMEN  
∠ 120°



# LE006



- CE
- IP20
- COLOUR CHANGE  
3000K 4000K 6500K
- CLASSE 2
- F

Articolo	Descrizione	PACKING /	INNER pcs	MASTER pcs
LE006	Lampada LED 1000lm con pantografo e lente di ingrandimento 3 diottrie	Color Box	4	12

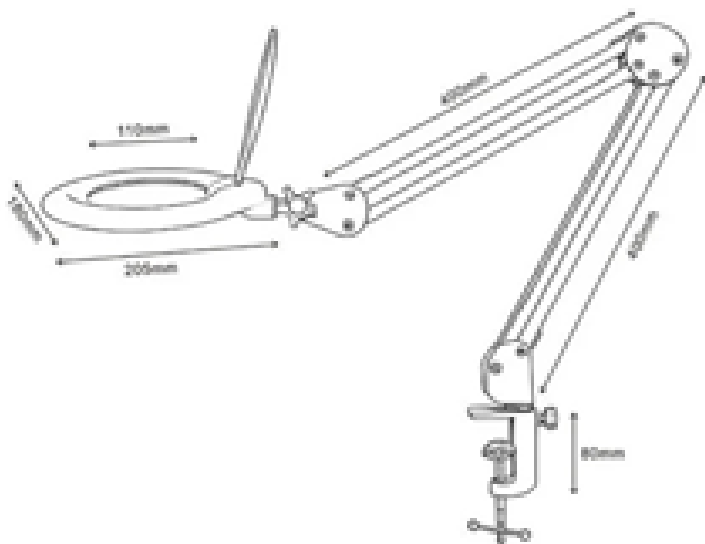



3X

COB LED

# IN286D



2 X AA  
NOT INCLUDED

CE

12 pcs  
DISPLAY

DIMMABLE

Articolo	Descrizione	PACKING 	INNER pcs	MASTER pcs
LE006	<b>WATSON:</b> Lente d'ingrandimento 3 LED COB. Colore Nero	Display 12 pz.	12	48



-  2835 SMD LED
-  50% LIGHT  
9 hours
-  100% LIGHT  
2,5 hours
-  USB Type C
-  Lithium 2 x 3,7V 1800mAh INCLUDED
-  4000K



**400 LUMEN**





# IR174

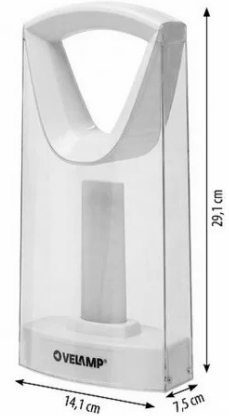







YouTube



CE  **4000K** 

Articolo	Descrizione	PACKING  / 	INNER  pcs	MASTER  pcs
<b>IR174</b>	<b>AQUA:</b> Lanterna ricaricabile anti blackout. 400 lumen	Color Box	6	6

-  2 x 16 pcs SMD LED
-  50% LIGHT  
14 hours
-  100% LIGHT  
2 hours
-  OFF 100% Dimmable
-  USB Type C
-  Lithium 3,7V 1500 mAh INCLUDED



**300 LUMEN**

# IR162NG



MANIGLIA ESTRAIBILE  
EXTRACTABLE HANDLE

SELEZIONE DI 1 O 2 TUBI  
SELECTION OF 1 OR 2 TUBES

VARIATORE DI LUCE  
LIGHT DIMMER

COMODA BASE DI APPOGGIO  
COMFORTABLE SUPPORT BASE







LED DI ALIMENTAZIONE  
POWER LED







JACK DI CARICA USB-C  
USB-C CHARGING JACK

CAVETTO USB  
USB CABLE

CE  **5000K** 

Articolo	Descrizione	PACKING  / 	INNER  pcs	MASTER  pcs
<b>IR162NG</b>	<b>TWIX:</b> Lampada di emergenza ricaricabile. 2 tubi LED, 300lm. 23cm	Color Box	6	24

# IR172



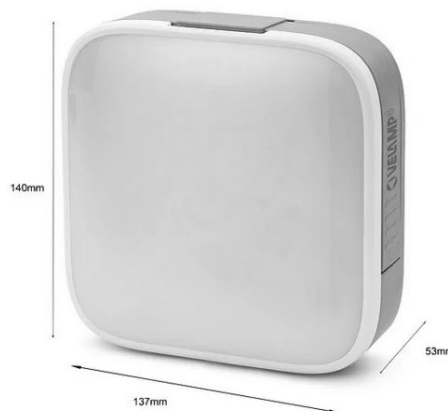

-  SMD 5731 LED
-  500 Lumen
-  4 hours
-  Diffuse Light
-  2 x LI-Ion  
3.7V 1200mAh  
(INCLUDED)
-  USB  
Type C







**5000K**

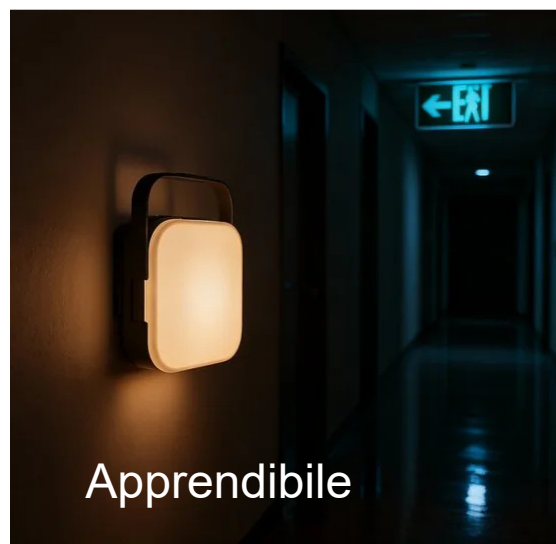

Articolo	Descrizione	PACKING  / 	INNER  pcs	MASTER  pcs
<b>IR172</b>	<b>GONG:</b> Lanterna ricaricabile anti blackout. 500 lumen con maniglia	Color Box	6	24



Apprendibile



# IL28NG

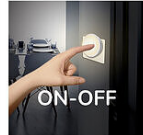

Articolo	Descrizione	PACKING /	INNER pcs	MASTER pcs
<b>IL28NG</b>	<b>TOUCH LED:</b> Punto luce LED con interruttore ON/OFF "TOUCH". Colore Bianco	Blister	12	72



# IL27NG



Articolo	Descrizione	PACKING /	INNER pcs	MASTER pcs
<b>IL27NG</b>	<b>DROPLED:</b> PUNTO LUCE LED CON INTERRUTTORE CDS Colore Bianco	Blister	12	72

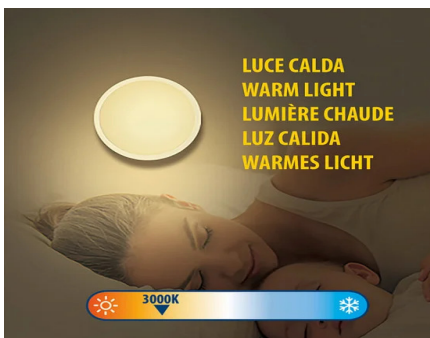

- CHINA
- ITALY
- NEW ZELAND
- GERMANY
- AUSTRALIA
- RUSSIA
- PACIFIC ISLANDS
- SWITZERLAND



- JAPAN
- ENGLAND
- AMERICA
- HONG KONG
- CANADA
- SINGAPORE
- PHILIPPINES
- MIDDLE EST



# SH112



Articolo	Descrizione	PACKING ☐ / ☐	INNER ☐ pcs	MASTER ☐ pcs
<b>SH112</b>	Adattatore da viaggio mondo verso Europa	Blister	6	72





## ADAPT-IT-103



Articolo	Descrizione	PACKING ☐ / ☑	INNER ☐ pcs	MASTER ☑ pcs
<b>ADAPT-IT-103</b>	<b>Adattatore presa tripla:</b> 3 prese 10A e 1 spina 10A	Hangable polybag	25	200



## ADAPT-IT-104



Articolo	Descrizione	PACKING ☐ / ☑	INNER ☐ pcs	MASTER ☑ pcs
<b>ADAPT-IT-104</b>	<b>Adattatore presa tripla:</b> 3 prese 10A/16A bipasso e 1 spina 16A	Hangable polybag	25	200



## ADAPT-IT-105



Articolo	Descrizione	PACKING ☐ / ☑	INNER ☐ pcs	MASTER ☐ pcs
<b>ADAPT-IT-105</b>	<b>Adattatore 3 prese :</b> 10/16A bipasso con Schuko e 1 spina 10A. Con protezione da sovraccarico. Dotato di interruttore	Hangable polybag	25	200



## ADAPT-IT-106



Articolo	Descrizione	PACKING ☐ / ☑	INNER ☐ pcs	MASTER ☐ pcs
<b>ADAPT-IT-106</b>	<b>Adattatore 3 prese</b> 10/16A bipasso con Schuko e 1 spina 16A. Con protezione da sovraccarico 3500W max. Dotato di interruttore	Hangable polybag	25	200



**Cavo da  
3 metri**

## MULTIT-I-S33



Articolo	Descrizione	PACKING ☐ / ☑	INNER ☐ pcs	MASTER ☐ pcs
<b>MULTIT-I-S33</b>	Multipresa italiana con spina grande 16A e 3 prese Schuko. Con interruttore. Cavo 3m. Colore Bianco	Plastic Hanger	5	25



## MULTIT-I-S30USB



Articolo	Descrizione	PACKING ☐ / ☑	INNER ☐ pcs	MASTER ☐ pcs
<b>MULTIT-I-S33</b>	Multipresa italiana con spina grande 16A, 3 prese Schuko e 2 prese USB. Con interruttore. Colore Bianco	Plastic Hanger	5	20





**Cavo da  
3 metri**

## MULTIT-I-S43



Articolo	Descrizione	PACKING ☐ / ☐	INNER ☐ pcs	MASTER ☐ pcs
<b>MULTIT-I-S43</b>	Multipresa italiana con spina grande 16A e 4 prese Schuko. Con interruttore. Cavo 3m. Colore Bianco	Plastic Hanger	5	25



**Cavo da  
3 metri**

## MULTIT-I-S53



Articolo	Descrizione	PACKING ☐ / ☐	INNER ☐ pcs	MASTER ☐ pcs
<b>MULTIT-I-S53</b>	Multipresa italiana con spina grande 16A e 5 prese Schuko. Con interruttore. Cavo 3m. Colore Bianco	Plastic Hanger	5	25

## MULTIT-I-S415



Articolo	Descrizione	PACKING ☐ / ☐	INNER ☐ pcs	MASTER ☐ pcs
<b>MULTIT-I-S415</b>	Multipresa SPAZIOZERO: spina 10A e 4 prese 10/16A bipasso. Con interruttore di protezione. Cavo 1,5m. Bianco	Plastic Hanger	6	30



10m



## DOMREEL-10-IT



Articolo	Descrizione	PACKING ☐ / ☝	INNER ☐ pcs	MASTER ☐ pcs
<b>DOMREEL-10-IT</b>	Avvolgicavo domestico 4 prese, vo H05VV-F3G1.0MM2, 10M ,CE	Blulk	10	10



7m



## DOMREEL-7-ITU

Avvolgicavo domestico 7m H05VV-F3G1.0MM2,  
2 prese 10/16A bipasso con Schuko  
E 2 prese USB-A+C.

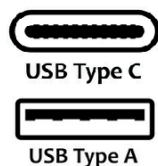

PACKING ☐ / ☝	INNER ☐ pcs	MASTER ☐ pcs
<b>Bulk</b>	<b>10</b>	<b>10</b>



Articolo	Descrizione	PACKING ☐ / ☝	INNER ☐ pcs	MASTER ☐ pcs
<b>DOMREEL-7-ITU</b>	Avvolgicavo domestico 7m H05VV-F3G1.0MM2,2 prese 10/16A bipasso con Schuko E 2 prese USB-A+C.	Blulk	10	10



**CAVI DI RAME SPESSE, PER UNA SICUREZZA PERFETTA**

Velamp utilizza dei fili di vero rame che garantiscono una buona conducibilità elettrica e un'eccezionale dispersione del calore. La guaina in PVC è ultra resistente.

**GERMAN MULTI-STANDARD PLUG**  
Deutscher Multistandard-Stecker



**250V**

**16A**



Compatible countries:  
Kompatible Länder:



# PLUG-DE-16A



**E: PROTECTIVE CONDUCTOR**  
Ensures safety through earthing (green/yellow)  
E: SCHUTZLEITER Gewährleistet die Sicherheit durch Erdung (grün/gelb)

**L: OUTER CONDUCTOR**  
Carries the operating current (brown)  
L: AUSSENLEITER Führt den Betriebsstrom (braun)

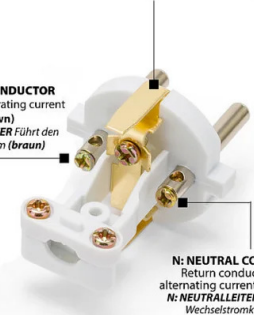

**N: NEUTRAL CONDUCTOR**  
Return conductor in the alternating current circuit (blue)  
N: NEUTRALLEITER Rückleiter im Wechselstromkreis (blau)

Articolo	Descrizione	PACKING ☐ / ☑	INNER ☐ pcs	MASTER ☐ pcs
<b>PLUG-DE-16A</b>	Spina Volante, 2P+T, 10/16A, Multistandard Tedesco/Italiano e Standard Francia, Colore bianco, 3500 W, 250V.	Hangable polybag	25	200

**GERMAN MULTI-STANDARD PLUG**  
Deutscher Multistandard-Stecker



**220V**

**16A**



Compatible countries:  
Kompatible Länder:



# PLUG-DE-16F



**E: PROTECTIVE CONDUCTOR**  
Ensures safety through earthing (green/yellow)  
E: SCHUTZLEITER Gewährleistet die Sicherheit durch Erdung (grün/gelb)

**L: OUTER CONDUCTOR**  
Carries the operating current (brown)  
L: AUSSENLEITER Führt den Betriebsstrom (braun)

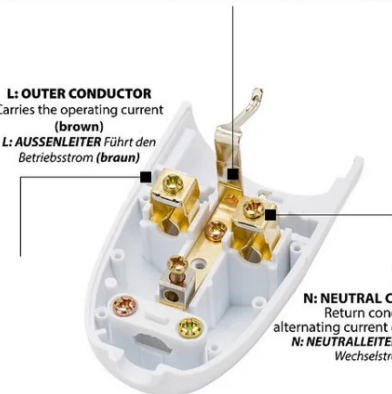

**N: NEUTRAL CONDUCTOR**  
Return conductor in the alternating current circuit (blue)  
N: NEUTRALLEITER Rückleiter im Wechselstromkreis (blau)

Articolo	Descrizione	PACKING ☐ / ☑	INNER ☐ pcs	MASTER ☐ pcs
<b>PLUG-DE-16A</b>	Presca Volante, 2P+T, 10/16A, Standard Tedesco (Schuko), Colore Bianco, 3500W, 250V.	Hangable polybag	25	200



# Spine e prese industriali



**VELAMP**  
Novità 2026

Codice Commerciale		Descrizione Articolo	Imballo	Q.tà inner	Q.tà Master
TD601		Spina elettrica CEE 230V 16A - IP44 - 3 pin	Polybag	10	100
TD603		Preso elettrica CEE 230V 16A - IP44 - 3 pin	Polybag	10	100
TD602		Spina elettrica CEE 230V 16A - IP67 - 3 pin	Polybag	10	60
TD604		Spina elettrica CEE 230V 16A - IP67 - 3 pin	Polybag	10	60
TD627		Spina elettrica CEE 400V 16A - IP44 - 4 pin	Polybag	10	100
TD629		Preso elettrica CEE 400V 16A - IP44 - 4 pin	Polybag	10	100
TD631		Spina elettrica CEE 400V 16A - IP44 - 5 pin	Polybag	10	60
TD633		50 graffette fissacavo, per cavo tondo diametro 16mm	Polybag	10	60
TD628		Spina elettrica CEE 400V 16A - IP67 - 4 pin	Polybag	10	60
TD630		Preso elettrica CEE 400V 16A - IP67 - 4 pin	Polybag	10	60
TD632		Spina elettrica CEE 400V 16A - IP67 - 5 pin	Polybag	10	60
TD634		Preso elettrica CEE 400V 16A - IP67 - 5 pin	Polybag	10	60



**40m max**  
(H05VV-F 3G1,5mm<sup>2</sup>)

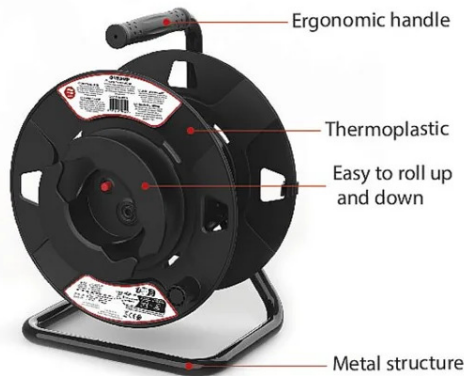

## REEL-EMPTY



Adatto per cavi: Suitable for cables: Convient aux câbles: Adecuado para cables: Geeignet für Kabel:	Carico massimo nominale Rated maximum load Charge maximale nominale Carga máxima nominal Maximale Nennlast									
	<table border="1"> <tr> <th></th> <th>Reeled</th> <th>Extended</th> </tr> <tr> <td>H05VV-F 3G1,5mm<sup>2</sup></td> <td>1000W/230V~</td> <td>3000W/230V~</td> </tr> <tr> <td>H05VV-F 3G1,0mm<sup>2</sup></td> <td>900W/230V~</td> <td>2300W/230V~</td> </tr> </table>		Reeled	Extended	H05VV-F 3G1,5mm <sup>2</sup>	1000W/230V~	3000W/230V~	H05VV-F 3G1,0mm <sup>2</sup>	900W/230V~	2300W/230V~
	Reeled	Extended								
H05VV-F 3G1,5mm <sup>2</sup>	1000W/230V~	3000W/230V~								
H05VV-F 3G1,0mm <sup>2</sup>	900W/230V~	2300W/230V~								

Articolo	Descrizione	PACKING	INNER	MASTER
			pcs	pcs
<b>REEL-EMPTY</b>	Avvolgicavo vuoto per cavi fino a 40 metri (H05VV-F 3G1,5mm <sup>2</sup> )	Bulk	2	2

## DMT500

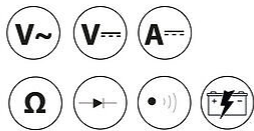



7 FUNZIONI IN 1 / 7 FUNCTIONS IN 1



Articolo	Descrizione	PACKING	INNER	MASTER
			pcs	pcs
<b>DMT500</b>	Mini tester digitale 6 in 1 con sonde	Color Box	10	60

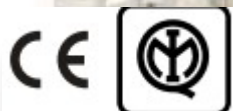





# Nuove misure MORSETTI A CAPPuccio



Codice Commerciale		Descrizione Articolo	Imballo	Q.tà inner	Q.tà Master
MG425		Morsetto unipolare 25mm <sup>2</sup>	Shrink	5	750
MG435		Morsetto unipolare 35mm <sup>2</sup>	Shrink	5	400

# Nuove misure FASCETTE IN NYLON



Codice Commerciale		Descrizione Articolo	Imballo	Q.tà inner	Q.tà Master
MG109		Fascette bianche in nylon 3,6x140 - 100pz	Polybag	10	250
MG116		Fascette bianche in nylon 3,6x370 - 100pz	Polybag	10	100
MG126		Fascette bianche in nylon 7,6x370 - 100pz	Polybag	10	50
MG209		Fascette nere in nylon 3,6x140 - 100pz	Polybag	10	250
MG216		Fascette nere in nylon 3,6x370 - 100pz	Polybag	10	100
MG228		Fascette nere in nylon 7,6x370 - 100pz	Polybag	10	50



## GRAFFETTE FISSA-CAVO

Codice Commerciale	Descrizione Articolo	Imballo	Q.tà inner	Q.tà Master
MG004	50 graffette fissacavo, per cavo tondo diametro 4mm	Polybag	10	500
MG005	50 graffette fissacavo, per cavo tondo diametro 5mm	Polybag	10	500
MG007	50 graffette fissacavo, per cavo tondo diametro 7mm	Polybag	10	400
MG008	50 graffette fissacavo, per cavo tondo diametro 8mm	Polybag	10	300
MG010	50 graffette fissacavo, per cavo tondo diametro 10mm	Polybag	10	200
MG012	50 graffette fissacavo, per cavo tondo diametro 12mm	Polybag	10	200
MG014	50 graffette fissacavo, per cavo tondo diametro 14mm	Polybag	10	100
MG016	50 graffette fissacavo, per cavo tondo diametro 16mm	Polybag	10	100
MG020	50 graffette fissacavo, per cavo tondo diametro 20mm	Polybag	10	80

**x50**



**GRAFFETTE FISSA-CAVO**  
**Sacchetti da 50 pz.**

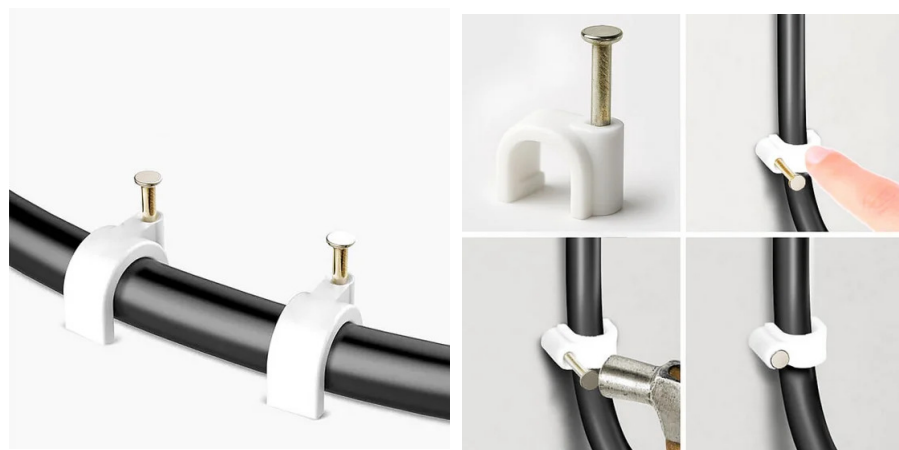



## CONDENSATORI DI SPUNTO 4 PIN CON FONDO PIATTO

Codice Commerciale	Descrizione Articolo	Imballo	Q.tà inner	Q.tà Master
MG8080FB	Condensatore di spunto per motori elettrici, 450V, capacità: 8µF, 4 pin / fondo piatto	Bulk	10	50
MG8090FB	Condensatore di spunto per motori elettrici, 450V, capacità: 90µF, 4 pin / fondo piatto	Bulk	10	50
MG8100FB	Condensatore di spunto per motori elettrici, 450V, capacità: 10µF, 4 pin / fondo piatto	Bulk	10	50
MG8120FB	Condensatore di spunto per motori elettrici, 450V, capacità: 12µF, 4 pin / fondo piatto	Bulk	10	50
MG8150FB	Condensatore di spunto per motori elettrici, 450V, capacità: 15µF, 4 pin / fondo piatto	Bulk	10	50
MG8180FB	Condensatore di spunto per motori elettrici, 450V, capacità: 18µF, 4 pin / fondo piatto	Bulk	10	50
MG8200FB	Condensatore di spunto per motori elettrici, 450V, capacità: 20µF, 4 pin / fondo piatto	Bulk	10	50
MG8250FB	Condensatore di spunto per motori elettrici, 450V, capacità: 25µF, 4 pin / fondo piatto	Bulk	10	50
MG8300FB	Condensatore di spunto per motori elettrici, 450V, capacità: 30µF, 4 pin / fondo piatto	Bulk	10	50
MG8350FB	Condensatore di spunto per motori elettrici, 450V, capacità: 35µF, 4 pin / fondo piatto	Bulk	10	50
MG8400FB	Condensatore di spunto per motori elettrici, 450V, capacità: 40µF, 4 pin / fondo piatto	Bulk	10	50
MG8450FB	Condensatore di spunto per motori elettrici, 450V, capacità: 45µF, 4 pin / fondo piatto	Bulk	10	50
MG8500FB	Condensatore di spunto per motori elettrici, 450V, capacità: 50µF, 4 pin / fondo piatto	Bulk	10	50
MG8600FB	Condensatore di spunto per motori elettrici, 450V, capacità: 60µF, 4 pin / fondo piatto	Bulk	10	50



*Novità*

- RECHARGEABLE
- LOW SELF DISCHARGE
- UP TO 1000 TIMES
- LED INDICATOR
- FAST CHARGING
- READY TO USE

## LR03-4USB



Articolo	Descrizione	PACKING ☐ / ☒	INNER ☐ pcs	MASTER ☒ pcs
<b>LR6-4USB</b>	4 batterie AAA Li-Ion ricaricabili tramite USB-C. 400mAh. Cavetto incluso.	Blister	12	144

## LR6-4USB



- RECHARGEABLE
- LOW SELF DISCHARGE
- UP TO 1000 TIMES
- LED INDICATOR
- FAST CHARGING
- READY TO USE



Articolo	Descrizione	PACKING ☐ / ☒	INNER ☐ pcs	MASTER ☒ pcs
<b>LR6-4USB</b>	4 batterie AA Li-Ion ricaricabili tramite USB-C. 1400mAh. Cavetto incluso	Blister	12	144

**LITHIUM BATTERY ( LiFePO4)**

**23748L**



PACKING	INNER	MASTER
	pcs	pcs
<b>Bulk</b>	<b>1</b>	<b>6</b>

Articolo	Descrizione	PACKING	INNER	MASTER
			pcs	pcs
<b>23748L</b>	<b>Batteria al litio ricaricabile LiFePO4 12,8V 7000mAh</b>	Blister	1	6

**23748L BATTERIA A LITIO VS BATTERIA AL PIOMBO**

<p><b>NOSTRA</b></p> <ul style="list-style-type: none"> <li>Scarica al 100% ✓</li> <li>4000+ Cicli di ricarica</li> <li>Ricarica costante</li> <li>Ricarica veloce ed efficiente</li> <li>Leggera</li> <li>Con BMS</li> </ul>	<p><b>ALTRE</b></p> <ul style="list-style-type: none"> <li>Scarica al 50% ✗</li> <li>500 Cicli di ricarica</li> <li>Calo di potenza</li> <li>Ricarica lenta</li> <li>Pesante</li> <li>No</li> </ul>
-------------------------------------------------------------------------------------------------------------------------------------------------------------------------------------------------------------------------------	-----------------------------------------------------------------------------------------------------------------------------------------------------------------------------------------------------

**USI DEL PRODOTTO**

**Dimensioni batteria: 148 x 95 x 62 mm**  
**Peso: 961 g**

Terminale Faston F2 per collegamenti facili e scarica ad alta velocità

**MODELLO IMPERMEABILE WATERPROOF DESIGN**

**12.8 V 7Ah**  
**23748L BATTERIA A LITIO PER QUATTORRUOTE PER BAMBINI**

Le immagini non sono reali, sono create con IA e sono puramente indicative. The images are not real, they are created with AI and are purely indicative.



## REPEL03

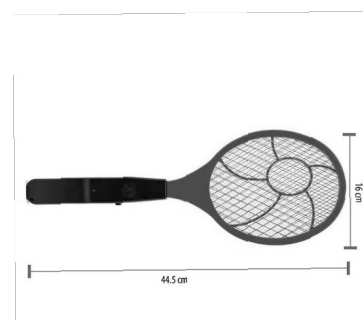

Articolo	Descrizione	PACKING ☐ / ☒	INNER ☐ pcs	MASTER ☐ pcs
<b>REPEL03</b>	<b>JOKO:</b> Racchetta elettrica anti zanzare	Display 12 pz.	12	12

### RECHARGEABLE



## REPEL05R



Articolo	Descrizione	PACKING ☐ / ☒	INNER ☐ pcs	MASTER ☐ pcs
<b>REPEL05R</b>	<b>BORG:</b> Racchetta elettrica anti zanzare ricaricabile	Hangable paper sleeve	6	24

# THERM07



Indoor receiver

Outdoor transmitter



Articolo	Descrizione	PACKING ☐ / ☐	INNER ☐ pcs	MASTER ☐ pcs
<b>THERM07</b>	<b>TOTAL METEO:</b> Stazione meteo con sonda esterna. Misurazione temperatura esterna e interna. Colore Bianco	Blister	12	48



Le immagini non sono reali, sono create con IA e sono puramente indicative. The images are not real, they are created with AI and are purely indicative.

Le immagini non sono reali, sono create con IA e sono puramente indicative. The images are not real, they are created with AI and are purely indicative.



**VELAMP**

molto di più oltre le torce



**SER010-...**



**SER012-...**



**SER014-...**



# VIXEN

**VIXEN: sveglia analogica al quarzo. Movimento silenzioso, luce e snooze.**

PACKING	INNER	MASTER
/	pcs	pcs
<b>Colour box</b>	<b>6</b>	<b>48</b>

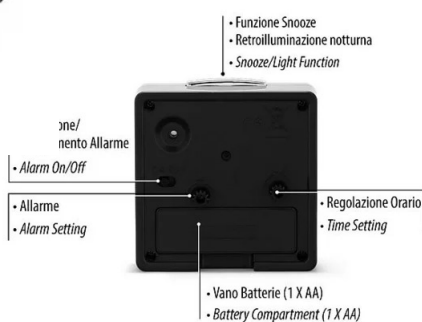

Codice Commerciale		Descrizione Articolo	Q-CODE
SER010-B		VIXEN: sveglia analogica al quarzo. Movimento silenzioso, luce e snooze. Nero	
SER010-S		VIXEN: sveglia analogica al quarzo. Movimento silenzioso, luce e snooze. Silver	
SER010-W		VIXEN: sveglia analogica al quarzo. Movimento silenzioso, luce e snooze. Bianco	

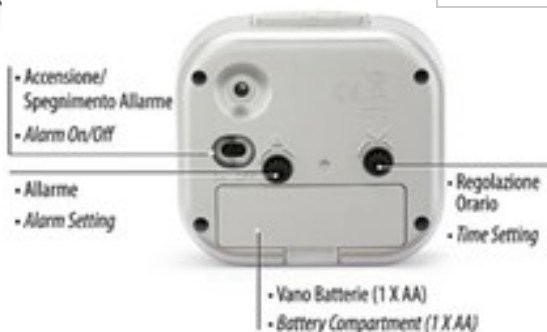

# PRANCER

**PRANCER:**  
sveglia analogica al quarzo.  
Movimento silenzioso, luce  
e snooze.

PACKING ☐ / ☑	INNER ☐ pcs	MASTER ☑ pcs
<b>Colour box</b>	<b>6</b>	<b>48</b>

Codice Commerciale		Descrizione Articolo	Q-CODE
SER012-B		PRANCER: sveglia analogica al quarzo. Movimento silenzioso, luce e snooze. Nero	
SER012-S		PRANCER: sveglia analogica al quarzo. Movimento silenzioso, luce e snooze. Silver	
SER012-W		PRANCER: sveglia analogica al quarzo. Movimento silenzioso, luce e snooze. Bianco	



# DASHER

**DASHER:**  
sveglia analogica al quarzo.  
Movimento silenzioso, luce  
e snooze.

PACKING ☐ / ☒	INNER ☐ pcs	MASTER ☐ pcs
<b>Colour box</b>	<b>6</b>	<b>48</b>

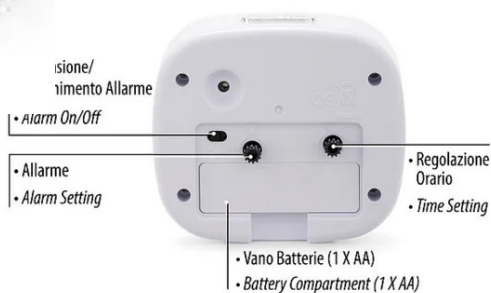

Codice Commerciale		Descrizione Articolo	Q-CODE
SER014-B		DASHER: sveglia analogica al quarzo. Movimento silenzioso, luce e snooze. Nero	
SER014-S		DASHER: sveglia analogica al quarzo. Movimento silenzioso, luce e snooze. Silver	
SER014-W		DASHER: sveglia analogica al quarzo. Movimento silenzioso, luce e snooze. Bianco	



Tommy

# OROLOGIO DA PARETE



# GOLDIE 10

**GOLDIE 10:**  
orologio da parete analogico  
al quarzo. Diametro 25cm.

PACKING 📦 / 📦	INNER 📦 pcs	MASTER 📦 pcs
<b>Colour box</b>	<b>6</b>	<b>12</b>





Codice Commerciale		Descrizione Articolo	Q-CODE
SER122-B		GOLDIE 10: orologio da parete analogico al quarzo. Ø 25cm. Nero	
SER122-S		GOLDIE 10: orologio da parete analogico al quarzo. Ø 25cm. Silver	
SER122-W		GOLDIE 10: orologio da parete analogico al quarzo. Ø 25cm. Bianco	



## GOLDIE 12

**GOLDIE 12:**  
orologio da parete analogico  
al quarzo. Diametro 30cm.

PACKING 	INNER  pcs	MASTER  pcs
<b>Colour box</b>	<b>6</b>	<b>12</b>



Codice Commerciale		Descrizione Articolo	Q-CODE
SER124-B		GOLDIE 12: orologio da parete analogico al quarzo. Ø 30cm. Nero	
SER124-S		GOLDIE 10: orologio da parete analogico al quarzo. Ø 30cm. Silver	
SER124-W		GOLDIE 10: orologio da parete analogico al quarzo. Ø 30cm. Bianco	



## EGP700

**Espositore con 50 accessori per cellulari. In bamboo**



PACKING	INNER	MASTER
/	pcs	pcs
<b>Display</b>	<b>1</b>	<b>1</b>



**Espositore in Bamboo naturale**

**Contiene :**



**EGP700-1 : 10 caricatori bianchi AC/DC 220V da 20W con uscita USB-A e USB-C**



**EGP700-2 : 10 cavi Sync & Charge, USB-A verso USB-C 1 metro (bianchi)**



**EGP700-4 : 10 cavi Sync & Charge, USB-C verso USB-C 1 metro (bianchi)**



**EGP700-3 : 15 cavi Sync & Charge, USB-C verso USB-C 2 metri (bianchi )**



**EGP700-5 : 05 Cavi Sync & Charge, USB-C verso Lightning 1 metro. (bianchi)**

**Tutti accessori di ultima generazione e adatti agli ultimi modelli di cellulari.  
Ottima qualità dei materiali, durevolezza garantita**



## EGP700-1

Caricatore AC/DC 220V da 20W  
 con uscita USB-A e USB-C. Bianco



PACKING ☞ / ☞	INNER ☞ pcs	MASTER ☞ pcs
<b>Bulk</b>	<b>5</b>	<b>200</b>

1m



## EGP700-2

Cavo Sync & Charge, USB-A verso  
 USB-C 1 metro. Bianco



PACKING ☞ / ☞	INNER ☞ pcs	MASTER ☞ pcs
<b>Bulk</b>	<b>5</b>	<b>500</b>

1m



## EGP700-3

Cavo Sync & Charge,  
 USB-C verso USB-C 1 metro.  
 Bianco



PACKING ☞ / ☞	INNER ☞ pcs	MASTER ☞ pcs
<b>Bulk</b>	<b>5</b>	<b>500</b>

2m



## EGP700-4

Cavo Sync & Charge, USB-C  
 verso USB-C 2 metri. Bianco



PACKING ☞ / ☞	INNER ☞ pcs	MASTER ☞ pcs
<b>Bulk</b>	<b>5</b>	<b>500</b>

1m



## EGP700-5

Cavo Sync & Charge, USB-C  
 verso Lightning 1 metro. Bianco



PACKING ☞ / ☞	INNER ☞ pcs	MASTER ☞ pcs
<b>Bulk</b>	<b>5</b>	<b>500</b>

# Novità

# S·T·A·K

By VELAMP



## REEL-2CES-33



Articolo	Descrizione	PACKING ☐ / ☑	INNER ☐ pcs	MASTER ☐ pcs
<b>REEL-2CES-33</b>	Prolunga in neoprene con avvolgicavo 33m per industria, costruzione, camper, campeggio, nautica. Avvolgicavo industriale IP44 con Spina CEE 3 poli e 3 prese (2 CEE+1 Schuko). Telaio in metallo.	Brown Box	1	1





VELAMP INDUSTRIES SRL - Viale Italia 59 - 20094 Corsico (MI) Italy  
Tel. +39 02.45.10.08.07 - Fax +39 02.44.01.627 - [info@velamp.com](mailto:info@velamp.com)  
[www.velamp.com](http://www.velamp.com)  
Velamp Industries France SARL SIRET : 7888 10869 00016 APE : 4791B – 6,  
Rue Edouard Nignon BP 37201 -  
44372 Nantes CEDEX 3  
Tel. +33 2 44 84 69 66 - Fax +33 2 44 84 69 49 - [spadulazzi@velamp.com](mailto:spadulazzi@velamp.com)  
Velamp Industries Deutschland GmbH -Westerbachstrasse 23f  
61476 Kronberg  
Tel. +49 171 83 17 407 - [c.bajjaly@velamp.com](mailto:c.bajjaly@velamp.com)